

LE B P1W

OSRAM OSTAR® Projection Power

OSRAM OSTAR Projection Power is a high luminance LED for projection applications.

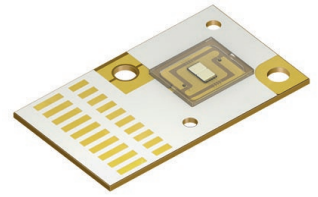

Applications

- Projection Home LED & Laser
- Projection Professional LED & Laser

Features:

- Package: OSTAR High Power Projection
- Chip technology: UX:3
- Typ. Radiation: 120° (Lambertian emitter)
- Color: $\lambda_{\text{dom}} = 459 \text{ nm}$ (• blue)
- Corrosion Robustness Class: 3B
- ESD: 2 kV acc. to ANSI/ESDA/JEDEC JS-001 (HBM, Class 2)

Ordering Information

Type	Total radiant flux ¹⁾ $I_F = 12000 \text{ mA}$ Φ_e	Ordering Code
LE B P1W-EZfZ-24	9700 ... 18000 mW	Q65112A4118
LE B P1W-EZfZ-VW	9700 ... 18000 mW	Q65112A4117

Maximum Ratings

Parameter	Symbol		Values
Operating Temperature	T_{op}	min.	-40 °C
		max.	125 °C
Storage Temperature	T_{stg}	min.	-40 °C
		max.	125 °C
Junction Temperature	T_j	max.	150 °C
Forward Current $T_j = 150$ °C; all chips operated in parallel	I_F	min.	200 mA
		max.	10000 mA
Forward Current pulsed $D = 0.25$; $f = 240$ Hz; $T_B = 25$ °C; all chips operated in parallel	$I_{F\ pulse}$		16000 mA
Surge Current $t_p \leq 10$ μ s; $D = 0.1$; $T_j = 150$ °C; all chips operated in parallel	I_{FS}	max.	20000 mA
ESD withstand voltage acc. to ANSI/ESDA/JEDEC JS-001 (HBM, Class 2)	V_{ESD}		2 kV
Reverse current ²⁾	I_R	max.	200 mA

Characteristics

$T_{\text{Board}} = 25\text{ °C}$; $I_{\text{F}} = 12000\text{ mA}$; $f = 1000\text{ Hz}$; $t_{\text{int}} = 100\text{ ms}$; $D = 0.25$; all chips operated in parallel

Parameter	Symbol		Values
Peak Wavelength	λ_{peak}	typ.	455 nm
Dominant Wavelength ³⁾	λ_{dom}	min.	444 nm
		typ.	459 nm
		max.	465 nm
Spectral bandwidth at 50% $I_{\text{rel,max}}$	$\Delta\lambda$	typ.	27 nm
Viewing angle at 50% I_{V}	2φ	typ.	120 °
Radiating surface	A_{color}	typ.	1.5 x 2.6 mm ²
Partial Flux acc. CIE 127:2007 ⁴⁾ $I_{\text{F}} = 12000\text{ mA}$	$\Phi_{\text{EV}, 120^\circ}$	typ.	0.82
Forward Voltage ⁵⁾ $I_{\text{F}} = 12000\text{ mA}$; all chips operated in parallel	V_{F}	min.	3.20 V
		typ.	3.35 V
		max.	4.30 V
Deviation of forward voltage of all chips	V_{F}	max.	135 mV
Reverse voltage (ESD device)	V_{RESD}	min.	45 V
Reverse voltage ²⁾ $I_{\text{R}} = 20\text{ mA}$	V_{R}	max.	1.2 V
Real thermal resistance junction/board	$R_{\text{thJB real}}$	typ.	1
Electrical thermal resistance junction/board with efficiency $\eta_{\text{e}} = 24\%$	$R_{\text{thJB elec.}}$	typ.	0.76

Brightness Groups

Group	Total radiant flux ¹⁾ $I_F = 12000 \text{ mA}$ min. Φ_e	Total radiant flux ¹⁾ $I_F = 12000 \text{ mA}$ max. Φ_e
EZ	9700 mW	11200 mW
FX	11200 mW	13000 mW
FY	13000 mW	15000 mW
FZ	15000 mW	18000 mW

Wavelength Groups

Group	Dominant Wavelength ³⁾ min. λ_{dom}	Dominant Wavelength ³⁾ max. λ_{dom}
V	444 nm	448 nm
W	448 nm	452 nm
2	452 nm	456 nm
3	456 nm	460 nm
4	460 nm	465 nm

Group Name on Label

Example: EZ-2

Brightness	Wavelength
EZ	2

Relative Spectral Emission ⁴⁾

$E_{rel} = f(\lambda)$; $I_F = 12000 \text{ mA}$; $T_J = 25 \text{ }^\circ\text{C}$; all chips operated in parallel

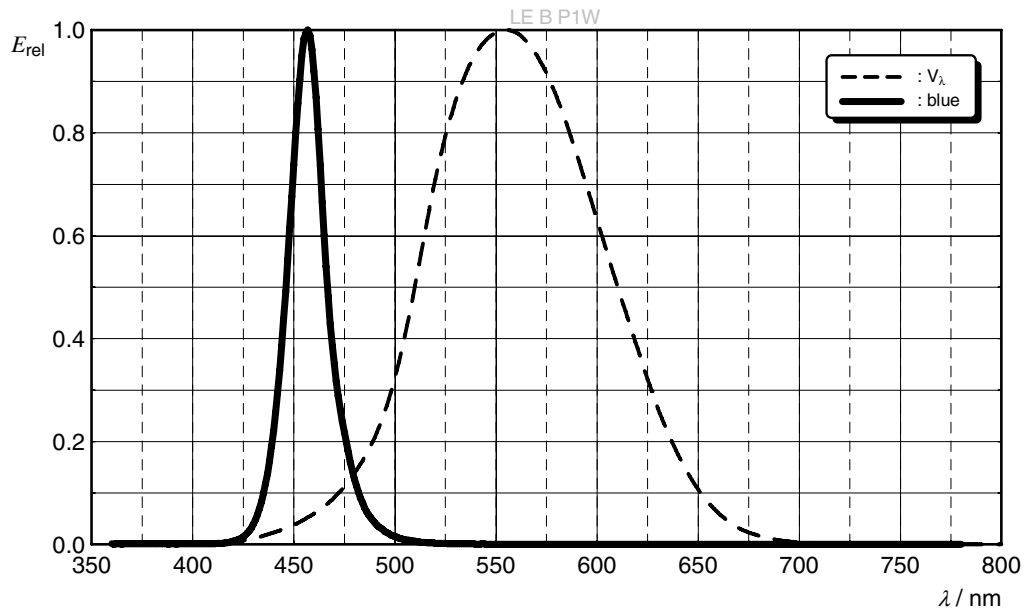

Radiation Characteristics ⁴⁾

$I_{rel} = f(\phi)$; $T_J = 25 \text{ }^\circ\text{C}$

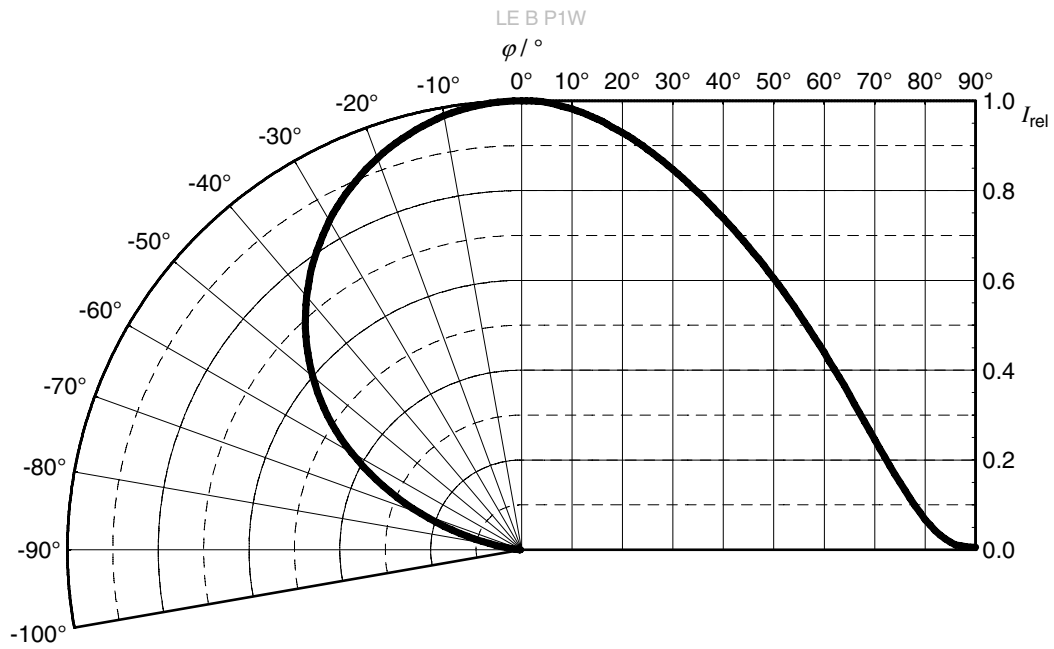

Discontinued

Relative Partial Flux ⁴⁾

$$\Phi_E(2\varphi)/\Phi_E(180^\circ) = f(\varphi); T_j = 25^\circ\text{C}$$

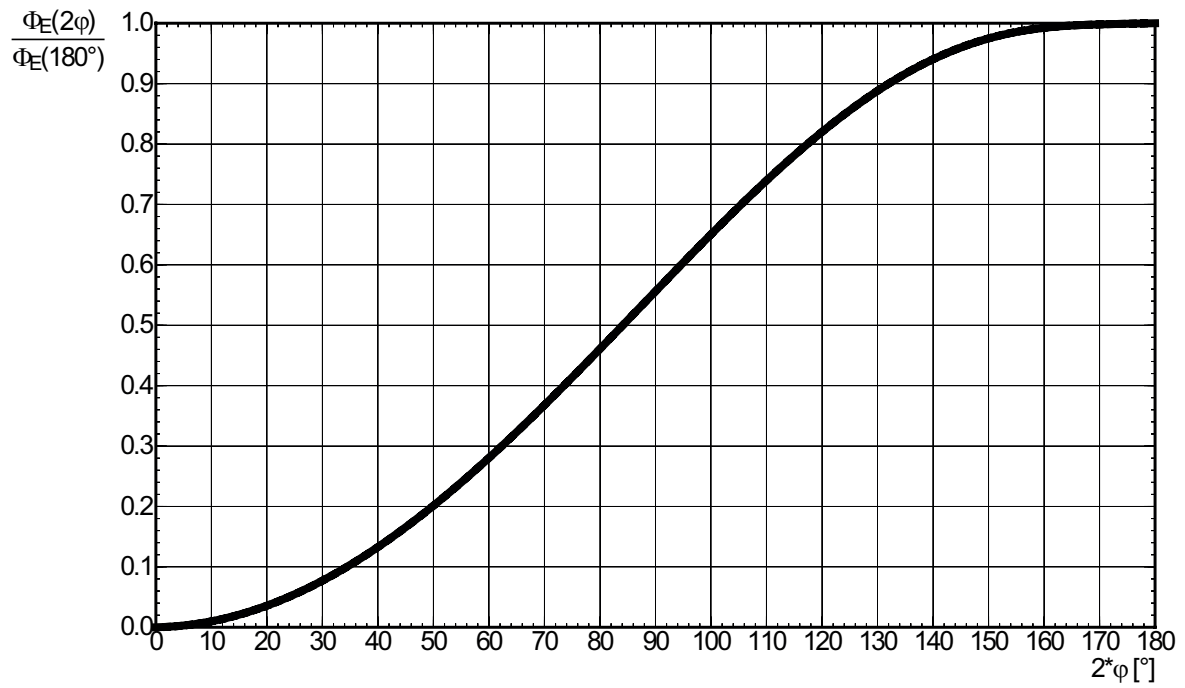

Forward current ^{4), 6)}

$I_F = f(V_F); T_J = 25\text{ °C};$
all chips operated in parallel

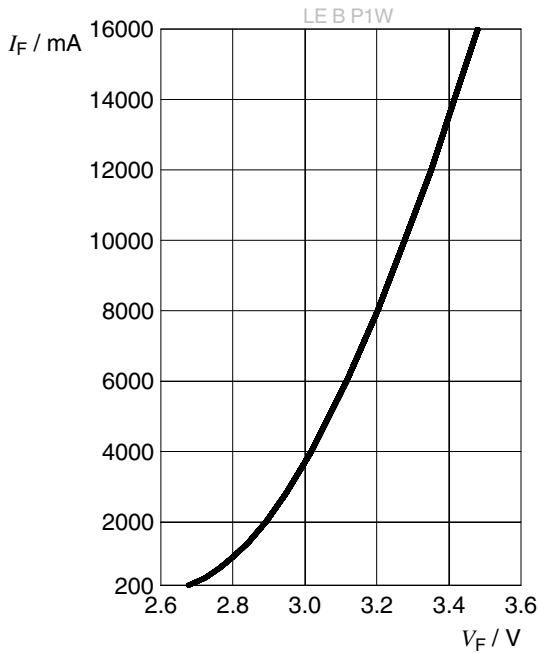

Relative Radiant Power ^{4), 6)}

$\Phi_E / \Phi_E(12000\text{ mA}) = f(I_F); T_J = 25\text{ °C};$
all chips operated in parallel

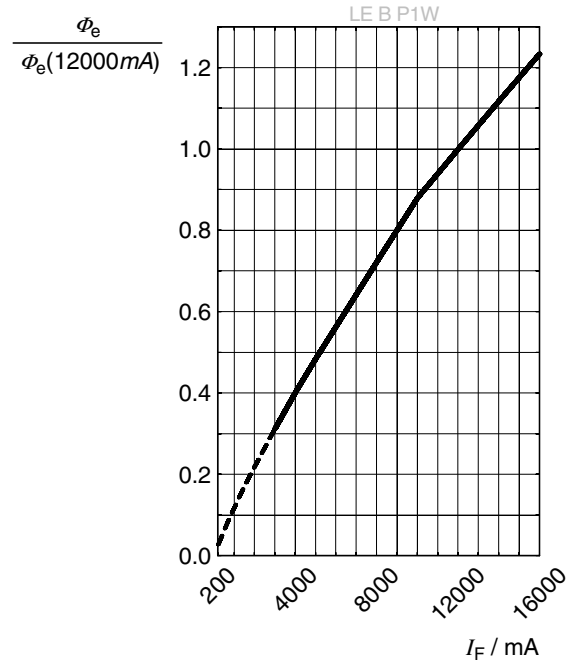

Dominant Wavelength ⁴⁾

$\Delta\lambda_{\text{dom}} = f(I_F); T_J = 25\text{ °C};$
all chips operated in parallel

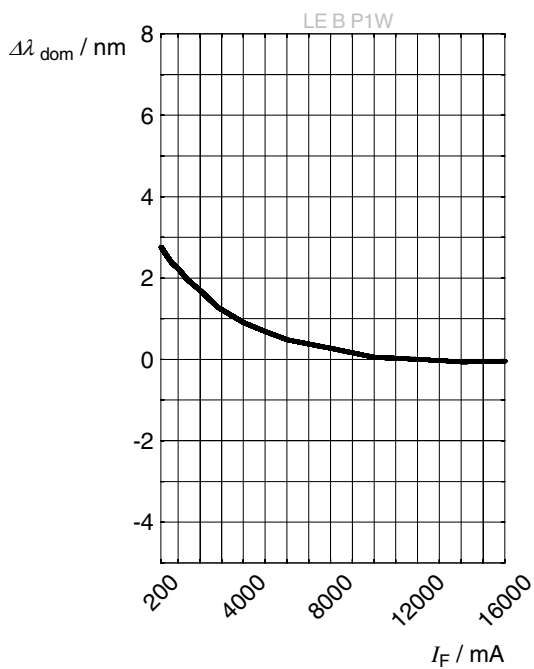

Discontinued

Forward Voltage ⁴⁾

$\Delta V_F = V_F - V_F(25\text{ °C}) = f(T_j); I_F = 12000\text{ mA};$
all chips operated in parallel

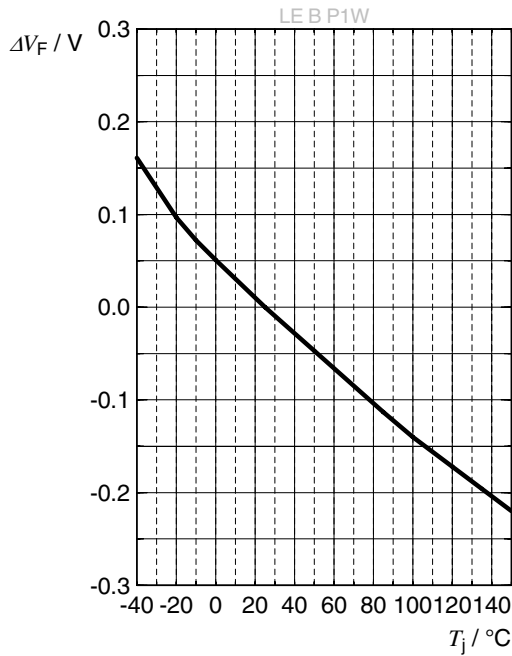

Relative Radiant Power ⁴⁾

$\Phi_E / \Phi_E(25\text{ °C}) = f(T_j); I_F = 12000\text{ mA};$
all chips operated in parallel

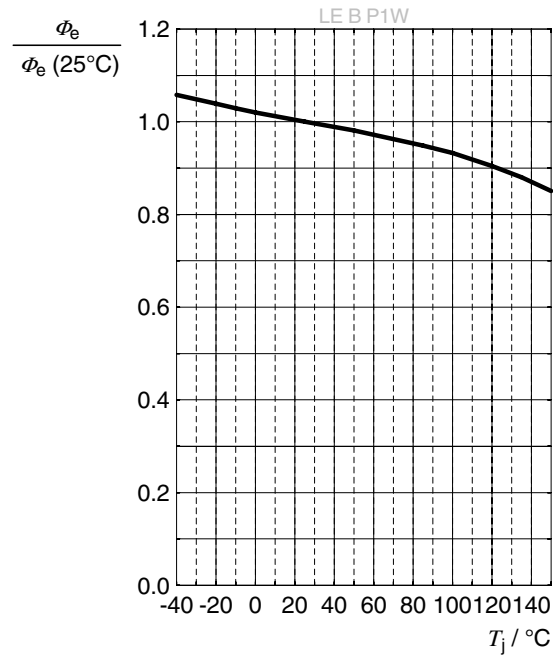

Dominant Wavelength ⁴⁾

$\Delta \lambda_{\text{dom}} = \lambda_{\text{dom}} - \lambda_{\text{dom}}(25\text{ °C}) = f(T_j); I_F = 12000\text{ mA};$
all chips operated in parallel

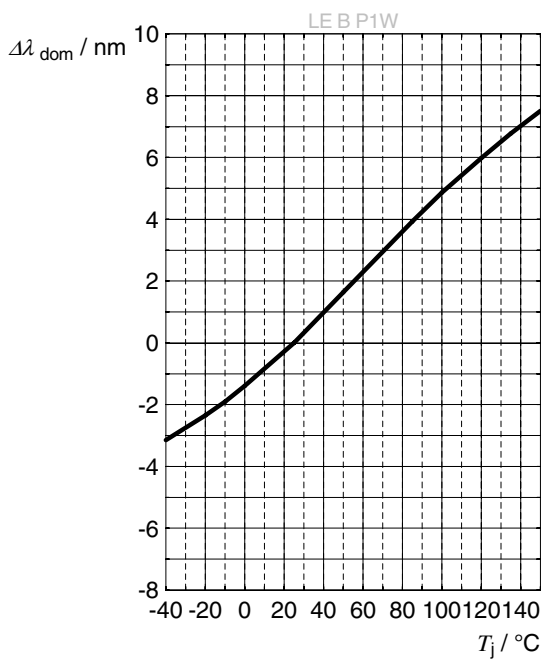

Discontinued

Dimensional Drawing ⁷⁾

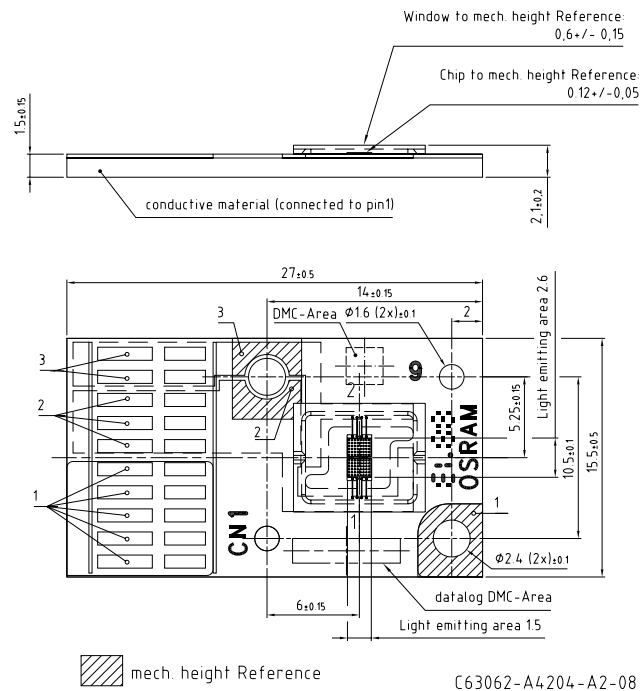

Further Information:

Approximate Weight:	5,000.0 mg
Corrosion test:	Class: 3B Test condition: $40^{\circ}\text{C} / 90\% \text{ RH} / 15 \text{ ppm H}_2\text{S} / 14 \text{ days}$ (stricter than IEC 60068-2-43)
ESD advice:	The device is protected by ESD device which is connected in parallel to the Chip.
Notes:	Package not suitable for any kind of wet cleaning or ultrasonic cleaning.
Connector:	Recommended connector: Molex Pico-SPOX™ Wire-to-Board Header, Part Number 87438-1043
Recommended mating connector:	Crimp Receptacle: Molex Pico-SPOX™ Wire-to-Board Housing, Part Number 87439-1000 Crimp Terminals: Molex Pico-SPOX™ Crimp Terminal, Part Number 87421-0000

Electrical Internal Circuit

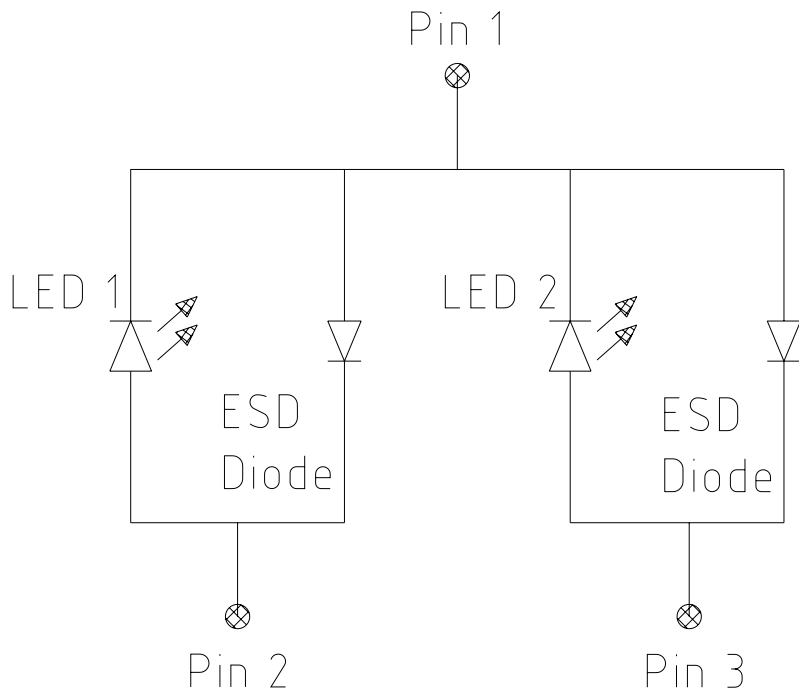

- 1: cathode
- 2: anode LED 1
- 3: anode LED 2

Reflow Soldering Profile

Product complies to MSL Level 2 acc. to JEDEC J-STD-020E

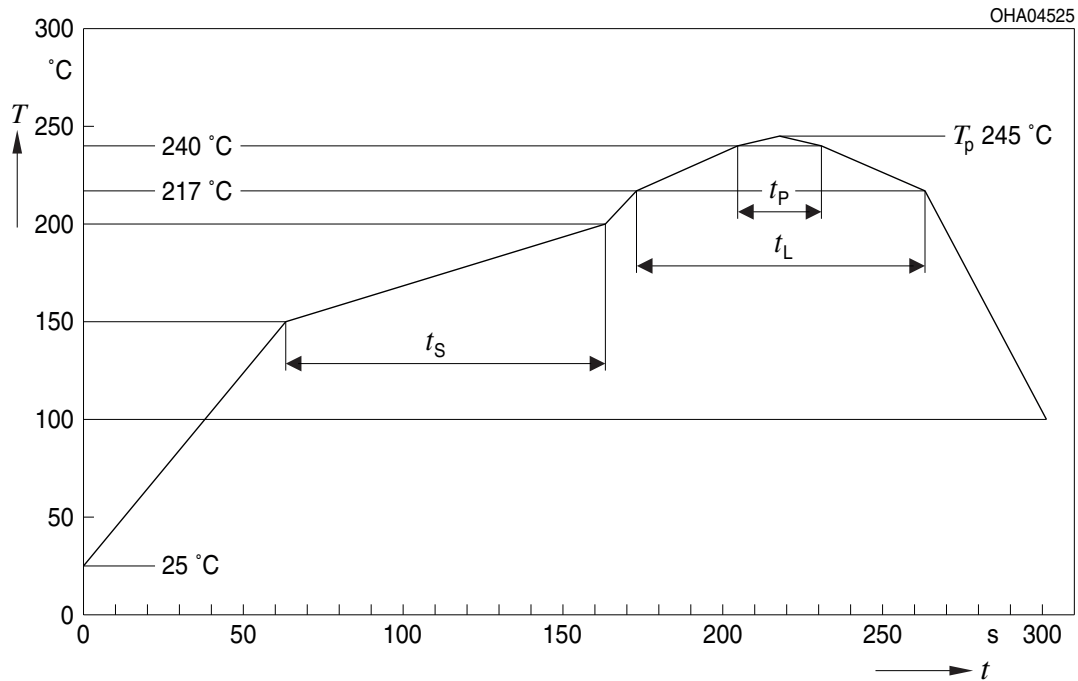

Profile Feature	Symbol	Pb-Free (SnAgCu) Assembly			Unit
		Minimum	Recommendation	Maximum	
Ramp-up rate to preheat ^{*)} 25 °C to 150 °C			2	3	K/s
Time t_s T_{Smin} to T_{Smax}	t_s	60	100	120	s
Ramp-up rate to peak ^{*)} T_{Smax} to T_p			2	3	K/s
Liquidus temperature	T_L		217		°C
Time above liquidus temperature	t_L		80	100	s
Peak temperature	T_p		245	260	°C
Time within 5 °C of the specified peak temperature $T_p - 5$ K	t_p	10	20	30	s
Ramp-down rate* T_p to 100 °C			3	6	K/s
Time 25 °C to T_p				480	s

All temperatures refer to the center of the package, measured on the top of the component
 *) slope calculation DT/Dt : Dt max. 5 s; fulfillment for the whole T-range

Discontinued

Taping ⁷⁾

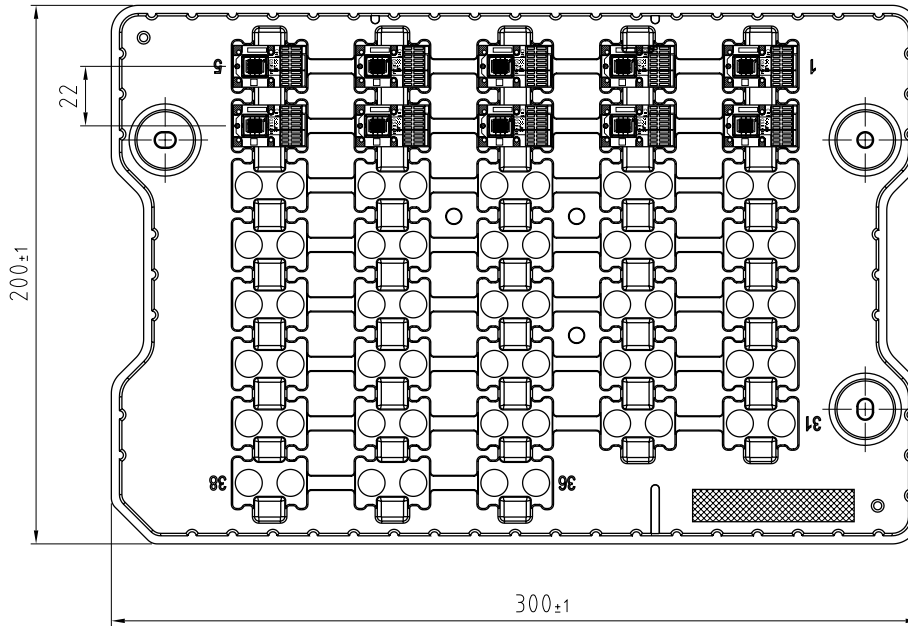

C63062-A4389-B10-01

Barcode-Product-Label (BPL)

OSRAM Opto Semiconductors LX XXXX BIN1: XX-XX-X-XXX-X

RoHS Compliant





(6P) BATCH NO: 1234567890

(1T) LOT NO: 1234567890 (9D) D/C: 1234

(X) PROD NO: 123456789 (Q) QTY: 9999 (G) GROUP: XX-XX-X-X

ML Temp ST
X XXX °C X

Pack: RXX
DEMY XXX
X_X123_1234.1234 X



OHA04563

Barcode-Tray-Label (BTL)

LE xxx xxx Group: xxxx-xxxx-xxxx

Data Matrix Code

xxxx BIN

MATERIAL: Material Number Batch Batch Number BIN: xxxx



OHA02684_1

Schematic Transportation Box ⁷⁾

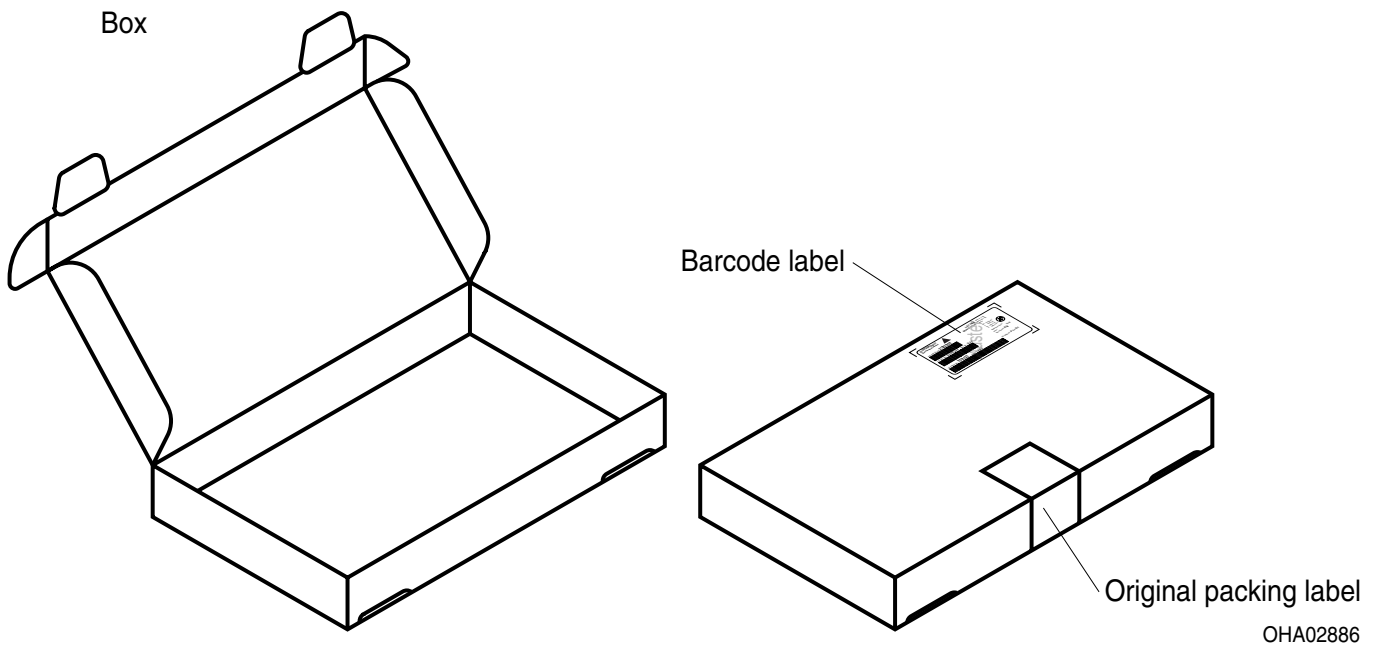

Dimensions of Transportation Box

Width	Length	Height
333 ± 5 mm	218 ± 5 mm	28 ± 5 mm
337 ± 5 mm	218 ± 5 mm	63 ± 5 mm

Type Designation System



Discontinued

Data Matrix Code Description

The Data Matrix Code bin information is Laser marked during testing

Content: aaaa@bbbb@ccc@dddd@eeee

Data Matrix Code Type: ECC200

a = Luminous Flux (Phiv) [lm] or Radiant Flux (Phie) [W]	(example: 3306)
b = Forward Voltage (Vf) [V]	(example: 3.46)
c = Wavelength (Ldom) [nm]	(example: 618)
d = Color Coordinate Cx	(example: 0.321)
e = Color Coordinate Cy	(example: 0.641)
@: Seperator = Blank	

Notes

The evaluation of eye safety occurs according to the standard IEC 62471:2006 (photo biological safety of lamps and lamp systems). Within the risk grouping system of this IEC standard, the device specified in this data sheet falls into the class **moderate risk (exposure time 0.25 s)**. Under real circumstances (for exposure time, conditions of the eye pupils, observation distance), it is assumed that no endangerment to the eye exists from these devices. As a matter of principle, however, it should be mentioned that intense light sources have a high secondary exposure potential due to their blinding effect. When looking at bright light sources (e.g. headlights), temporary reduction in visual acuity and afterimages can occur, leading to irritation, annoyance, visual impairment, and even accidents, depending on the situation.

Subcomponents of this device contain, in addition to other substances, metal filled materials including silver. Metal filled materials can be affected by environments that contain traces of aggressive substances. Therefore, we recommend that customers minimize device exposure to aggressive substances during storage, production, and use. Devices that showed visible discoloration when tested using the described tests above did show no performance deviations within failure limits during the stated test duration. Respective failure limits are described in the IEC60810.

For further application related information please visit www.osram-os.com/appnotes

Disclaimer

Attention please!

The information describes the type of component and shall not be considered as assured characteristics. Terms of delivery and rights to change design reserved. Due to technical requirements components may contain dangerous substances.

For information on the types in question please contact our Sales Organization.

If printed or downloaded, please find the latest version on the OSRAM OS website.

Packing

Please use the recycling operators known to you. We can also help you – get in touch with your nearest sales office. By agreement we will take packing material back, if it is sorted. You must bear the costs of transport. For packing material that is returned to us unsorted or which we are not obliged to accept, we shall have to invoice you for any costs incurred.

Product and functional safety devices/applications or medical devices/applications

OSRAM OS components are not developed, constructed or tested for the application as safety relevant component or for the application in medical devices.

OSRAM OS products are not qualified at module and system level for such application.

In case buyer – or customer supplied by buyer – considers using OSRAM OS components in product safety devices/applications or medical devices/applications, buyer and/or customer has to inform the local sales partner of OSRAM OS immediately and OSRAM OS and buyer and /or customer will analyze and coordinate the customer-specific request between OSRAM OS and buyer and/or customer.

Glossary

- 1) **Brightness:** Brightness values are measured during a pulse train of 100 ms with a pulse width of 250 μ s and a frequency of 1 kHz, with an internal reproducibility of \pm 8 % and an expanded uncertainty of \pm 11 % (acc. to GUM with a coverage factor of $k = 3$). The peak brightness is calculated according to the pulse duration and frequency.
- 2) **Reverse Operation:** This product is intended to be operated applying a forward current within the specified range. Applying any continuous reverse bias or forward bias below the voltage range of light emission shall be avoided because it may cause migration which can change the electro-optical characteristics or damage the LED.
- 3) **Wavelength:** The wavelength is measured during a pulse train of 100 ms with a pulse width of 250 μ s and a frequency of 1 kHz, with an internal reproducibility of \pm 0,5 nm and an expanded uncertainty of \pm 1 nm (acc. to GUM with a coverage factor of $k=3$).
- 4) **Typical Values:** Due to the special conditions of the manufacturing processes of semiconductor devices, the typical data or calculated correlations of technical parameters can only reflect statistical figures. These do not necessarily correspond to the actual parameters of each single product, which could differ from the typical data and calculated correlations or the typical characteristic line. If requested, e.g. because of technical improvements, these typ. data will be changed without any further notice.
- 5) **Forward Voltage:** The forward voltage is measured during a pulse of typical 250 μ s, with an internal reproducibility of \pm 0,05 V and an expanded uncertainty of \pm 0,1 V (acc. to GUM with a coverage factor of $k=3$).
- 6) **Characteristic curve:** In the range where the line of the graph is broken, you must expect higher differences between single devices within one packing unit.
- 7) **Tolerance of Measure:** Unless otherwise noted in drawing, tolerances are specified with \pm 0.1 and dimensions are specified in mm.

Revision History

Version	Date	Change
1.14	2018-11-28	New Layout
1.15	2019-09-05	Tray
1.16	2020-06-30	Not for new design
1.17	2020-10-13	Discontinued

Published by OSRAM Opto Semiconductors GmbH EU RoHS and China RoHS compliant product
Leibnizstraße 4, D-93055 Regensburg
www.osram-os.com © All Rights Reserved.



此产品符合欧盟 RoHS 指令的要求；
按照中国的相关法规和标准，不含有毒有害物质或元素。